

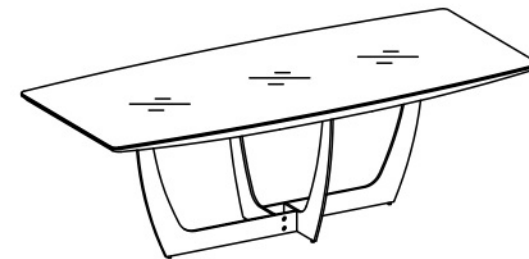

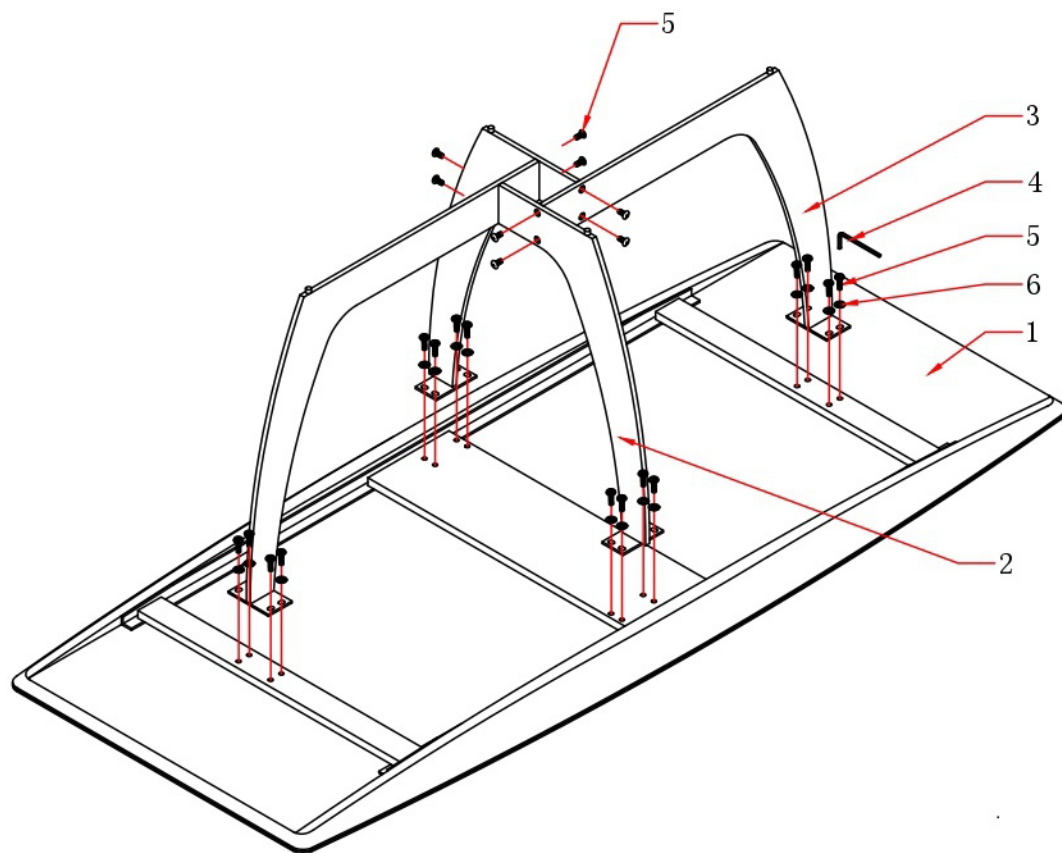



# EAC



### ИНСТРУКЦИЯ ПО СБОРКЕ

6		Ø17-Ø8.5x1.5	16
5		M8x20	24
4		5MM	1
3		640*710x120	2
2		374x710x120	2
1		1600x850x73	1
NN	ДЕТАЛИ И КРЕПЕЖНЫЕ ЭЛЕМЕНТЫ		ШТ

**СТОЛ ОБЕДЕННЫЙ 58DB-DT14803S**